

# DVC953

## DC/DC converter module



Abbildung ähnlich / device similar to figure



DVC953-derivate table

Type	Input voltage		Output voltage	Output current	Cat. No.
	Nom.	Tol.	Nom.	Continuous	
DVC953-48/80-13,8-CAN	48 / 80 VDC	24 - 110 VDC	13,8 VDC	80 A	105185/x/yyy

\*Order option:

.../x/...: Accessory variant

.../0/...without accessory

.../20/...with heatsink

More on request

.../yyy: Setting (Standard setting or customized)

.../000 DC-Standard CAN 2.0A

.../001 DC-Standard CAN J1939

Customer-specific parameterization on request

## DC/DC converter module

## DVC953

Alle Daten gemessen bei 48/80VDC, 70A / 80A und 25°C Umgebungstemperatur, wenn nicht anders gekennzeichnet. | All parameters are specified at 48/80VDC, 70A / 80A and 25°C ambient, if not marked otherwise.  
 Technische Änderungen und Irrtümer vorbehalten. | Technical modifications and mistakes reserved.

Mit den Angaben im Katalog und in den Datenblättern werden Produkte beschrieben, nicht Eigenschaften zugesichert. Belastung mit „Grenzwerten“ (einfache Kombination) ist zulässig ohne bleibende Schäden der Produkte. Betrieb der Geräte mit Grenzwertbelastung für längere Zeit kann die Zuverlässigkeit beeinträchtigen. Grenzwerttoleranzen unterliegen üblichen Schwankungen. | Products are described by information contained in catalogs and data-sheets. It is not be considered as assured qualities. Stresses listed under „Maximum Rating“ (one at a time) may be applied to devices without resulting in permanent damage. The operation of the equipment for extended periods may affect device reliability. Limiting value tolerance are subject to usual fluctuation margins.

# 1 Input

<b>Input voltage range</b>	-	see DVC953-derivate table on page 1 (valid for continuous operation)
<b>Undervoltage range</b>	0 - 24 VDC	Class C*
<b>Lower restricted operation range</b>	24 - 34 VDC	Continuous operation, class B*
<b>Unrestricted operation range</b>	34 - 110 VDC	Continuous operation, class A*
<b>Upper restricted operation range</b>	110 - 112 VDC	≤ 5 s, class B*
<b>Overvoltage range</b>	112 - 120 VDC	≤ 100 ms, class B*
<b>Max. current consumption</b>	< 39,5 A	@U <sub>set</sub> = 16 VDC, I <sub>max</sub> see fig 10.3
<b>Input capacity</b>	approx. 19 µF	Attention: No inrush current limitation in the device. Provide precharge section in the application.
<b>No-load current consumption</b>	< 30 mA < 100 mA	device in standby mode device in Buck-mode see fig. 10.1
<b>No-load input power</b>	< 1,6 W < 3,8 W	device in standby mode device in Buck-mode see fig. 10.2

## \* Evaluation criteria for the operation behavior

The following evaluation criteria describe the functional state of the DC/DC converter as a function of the operation input voltage.

<b>Class A</b>	Unrestricted operation range	The DC/DC converter operates as designed in compliance with the tolerances specified in the data sheet.
<b>Class B</b>	Lower and upper restricted operation range	One or more functions may go beyond the specified tolerance. After returning to the unrestricted operation range, the DC/DC converter operates again as designed.
<b>Class C</b>	Undervoltage and overvoltage range	One or more functions do not work as intended. After returning to the unrestricted operation range, the DC/DC converter operates again as designed.

## 2 Output

<b>Nominal output voltage <math>U_{nom}</math></b>	13,8 VDC	see DVC953-derivate table on page 1
<b>Output voltage range <math>U_{set}</math></b>	2 - 16 VDC	for an set value below 10,5 VDC see also chapter 8
<b>Initial accuracy <math>N_{initial}</math></b>	+0,2% / -0,8% $U_{nom}$	includes adjust accuracy and component tolerances
<b>Input regulation tolerance <math>N_{input}</math></b>	$\pm 0,6\%$ $U_{nom}$	-
<b>Load regulation tolerance <math>N_{load}</math></b>	+0,8% / -0,5% $U_{nom}$	-
<b>Ripple &amp; Noise <math>N_{RN}</math></b>	$< \pm 3\%$ $U_{nom}$	$U_{RN} < 828$ mVpp Measurement bandwidth 20 MHz
<b>Overall tolerance <math>N_{overall}</math> (0-20Hz)</b>	+1,6% / -1,9% $U_{nom}$	$N_{overall} = N_{initial} + N_{input} + N_{load}$ Value represents worst case scenario for a bandwidth from 0 Hz up to 20 Hz.
<b>Overall tolerance <math>N_{overall}</math> (0-20MHz)</b>	+4,6% / -4,9% $U_{nom}$	$N_{overall} = N_{initial} + N_{input} + N_{load} + N_{RN}$ Value represents worst case scenario for a bandwidth from 0 Hz up to 20 MHz.
<b>Ambient temperature tolerance <math>N_{temp}</math></b>	+2% / -1,5% $U_{nom}$	-
<b>Max. continuous output current <math>I_{max}</math></b>	80 A	-
<b>Max. continuous output power <math>P_{max}</math></b>	$< 1280$ W	@ $U_{set} = 16$ VDC
<b>Current limiting</b>	$< I_{max} + 10\%$	From $1.0 \times I_{max}$ $U_{out}$ can drop

## 3 Environment

Working temperature (environment)	-10°C ... +45°C	-
Max. permissible temperature of the mounting surface	< +45°C	-
Overtemperature protection	+90°C (internal)	Automatic switch-off in case of overtemperature. Automatic turn on after 5°C hysteresis, see also chapter 8
Storage temperature	-40°C ... +85°C	-
Humidity	< 95%	-
Dewing	allowed	-
Shock test acc. to DIN EN 60068-2-27	-	half sinusoidal (Excitation) 250m/s <sup>2</sup> (Peak acceleration) 6ms (Duration) 3.000 shocks to each axis (Quantity) ±X, ±Y, ±Z (Axis)
Vibration test acc. to DIN EN 60068-2-6	-	sinusoidal (Excitation) 30m/s <sup>2</sup> (acceleration) 10 - 500Hz (frequenc, floating) 2h per axis (Duration), 1 Oct/min X, Y, Z (Axis)
Degree of protection acc. to EN60529	IP67	Limited by connection technology

## 4 General data

Insulation strength	1 kVDC 1 kVDC 1 kVDC 500 VDC	Input voltage against enclosure Input voltage against output Input voltage against CAN Output against enclosure
Max. efficiency	< 94,5%	see fig. 10.4
Average efficiency	< 93%	Averaging of the efficiency values at 25%, 50%, 75% and 100% of the nominal output power. See fig ??
Dimensions		see fig. 9.1
Enclosure	Aluminium	-
Weight	approx. 4,5 kg	-

## DC/DC converter module

## DVC953

Alle Daten gemessen bei 48/80VDC, 70A / 80A und 25°C Umgebungstemperatur, wenn nicht anders gekennzeichnet. | All parameters are specified at 48/80VDC, 70A / 80A and 25°C ambient, if not marked otherwise.  
 Technische Änderungen und Irrtümer vorbehalten. | Technical modifications and mistakes reserved.

Mit den Angaben im Katalog und in den Datenblättern werden Produkte beschrieben, nicht Eigenschaften zugesichert. Belastung mit „Grenzwerten“ (einfache Kombination) ist zulässig ohne bleibende Schäden der Produkte. Betrieb der Geräte mit Grenzwertbelastung für längere Zeit kann die Zuverlässigkeit beeinträchtigen. Grenzwerttoleranzen unterliegen üblichen Schwankungen. | Products are described by information contained in catalogs and data-sheets. It is not be considered as assured qualities. Stresses listed under „Maximum Rating“ (one at a time) may be applied to devices without resulting in permanent damage. The operation of the equipment for extended periods may affect device reliability. Limiting value tolerance are subject to usual fluctuation margins.

## 5 Standards

### EMC (Electromagnetic Compatibility)

Title	Standard	Data
Emitted interference	EN12895 EN61204-3	- according to 6.4.2, Table H.3, for residential, commercial and light industrial environments (Class B, cable length < 3 m)
Immunity	EN12895 EN61204-3	- according to 7.2.3: Immunity level for industrial environment (cable length < 3 m)

### Electrical safety

Title	Standard	Data
Low-voltage switch mode power supplies - Safety requirements	DIN EN 61204-7	-
Safety of industrial trucks - Electrical requirements	designed according to DIN EN 1175* (PRN2014)	-

\* The system integrator is responsible for compliance of all product-specific requirements in the end application.

## 6 Installation and safety instructions

In addition to the general installation and safety instructions for DC/DC converters, the following values and supplements apply:

Mounting points	-	Mounting over 4x M6 threads Tightening torque: 6 Nm see fig. 9.1
Installation orientation	-	any
Connection input / output	-	see chapter 7
Input fuse	-	No integrated input fuse. A fuse must be provided externally by the customer application.
Reverse polarity protection	-	No reverse polarity protection at the input or output of the device. If the polarity is reversed at the input, the input fuse to be connected in series is tripped.
Precharge section	-	Attention: No inrush current limitation in the device. Provide precharge section in the application.

The general installation and safety instructions for DC/DC converters can be found at: [www.deutronic.com](http://www.deutronic.com)

## DC/DC converter module

## DVC953

Alle Daten gemessen bei 48/80VDC, 70A / 80A und 25°C Umgebungstemperatur, wenn nicht anders gekennzeichnet. | All parameters are specified at 48/80VDC, 70A / 80A and 25°C ambient, if not marked otherwise.  
 Technische Änderungen und Irrtümer vorbehalten. | Technical modifications and mistakes reserved.

Mit den Angaben im Katalog und in den Datenblättern werden Produkte beschrieben, nicht Eigenschaften zugesichert. Belastung mit „Grenzwerten“ (einfache Kombination) ist zulässig ohne bleibende Schäden der Produkte. Betrieb der Geräte mit Grenzwertbelastung für längere Zeit kann die Zuverlässigkeit beeinträchtigen. Grenzwerttoleranzen unterliegen üblichen Schwankungen. | Products are described by information contained in catalogs and data-sheets. It is not be considered as assured qualities. Stresses listed under „Maximum Rating“ (one at a time) may be applied to devices without resulting in permanent damage. The operation of the equipment for extended periods may affect device reliability. Limiting value tolerance are subject to usual fluctuation margins.

## 7 Connections

### Input

AMPHENOL, PL082X-61-6:

- 2 pole connector
- Matching mating connector: AMPHENOL, PL182X-61-6
- cable cross section: 6 mm<sup>2</sup>

### Output

Cables with lugs

- 2 integrated cables with cable lug
- cable cross section: 16 mm<sup>2</sup>

+Uout red, length: 865 mm, end with M8 not isolated cable lug

-Uout black, length: 600 mm, end with M10 not isolated cable lug

### Signal (CAN)

SUB-D 9-pole:

PIN 2: CAN Low

PIN 7: CAN High

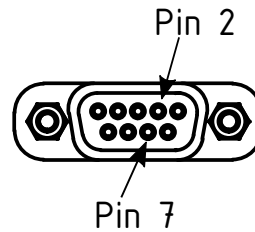
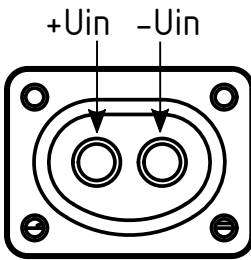

## 8 Operating condition

Following errors and warnings are also transmitted via CAN (J1939)

operating condition	operating status		threshold value	unit	note
	error (device off)	warning (power derating possible)			
input voltage above maximum threshold value		X	110	V	hysteresis at 100 V
input voltage below minimum threshold value	X		21	V	no hysteresis
output voltage above maximum threshold value		X	16	V	no set point greater than 16V accepted; external voltage greater than 16V triggers warning
output voltage below minimum threshold value		X	10,5	V	
output current equal to or greater than maximum threshold value		X	80	A	
internal converter temperature above warning level, but below maximum threshold value		X	85	°C	
internal converter temperature above maximum threshold value	X		90	°C	hysteresis at 85°C

## DC/DC converter module

## DVC953

Alle Daten gemessen bei 48/80VDC, 70A / 80A und 25°C Umgebungstemperatur, wenn nicht anders gekennzeichnet. | All parameters are specified at 48/80VDC, 70A / 80A and 25°C ambient, if not marked otherwise.  
 Technische Änderungen und Irrtümer vorbehalten. | Technical modifications and mistakes reserved.

Mit den Angaben im Katalog und in den Datenblättern werden Produkte beschrieben, nicht Eigenschaften zugesichert. Belastung mit „Grenzwerten“ (einfache Kombination) ist zulässig ohne bleibende Schäden der Produkte. Betrieb der Geräte mit Grenzwertbelastung für längere Zeit kann die Zuverlässigkeit beeinträchtigen. Grenzwerttoleranzen unterliegen üblichen Schwankungen. | Products are described by information contained in catalogs and data-sheets. It is not be considered as assured qualities. Stresses listed under „Maximum Rating“ (one at a time) may be applied to devices without resulting in permanent damage. The operation of the equipment for extended periods may affect device reliability. Limiting value tolerance are subject to usual fluctuation margins.

## 9 Dimensions

All dimensions are given in millimeters and have a general tolerance according to DIN ISO 2768 - m.

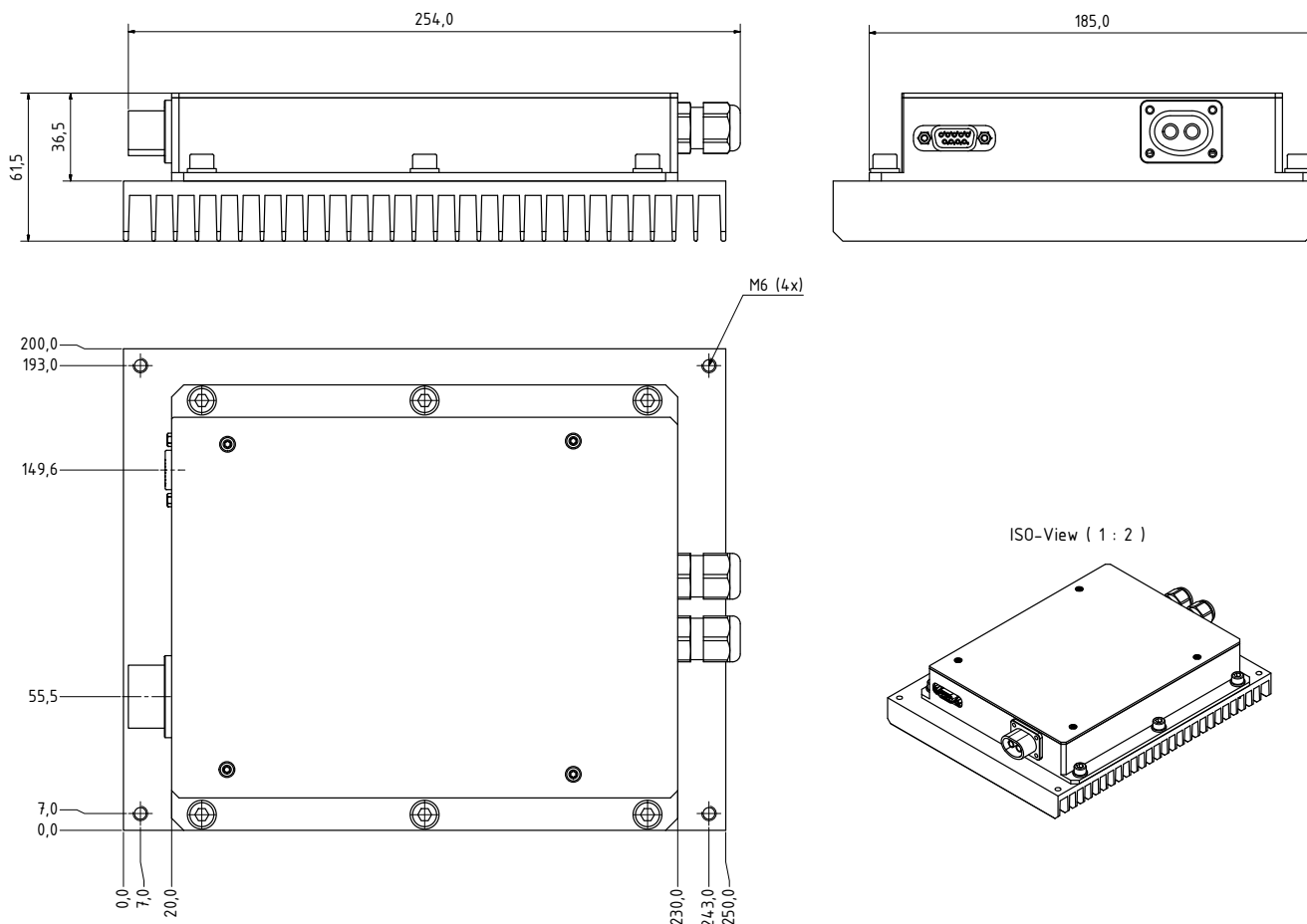

Figure 9.1: Dimensions

## DC/DC converter module

## DVC953

Alle Daten gemessen bei 48/80VDC, 70A / 80A und 25°C Umgebungstemperatur, wenn nicht anders gekennzeichnet. | All parameters are specified at 48/80VDC, 70A / 80A and 25°C ambient, if not marked otherwise.  
 Technische Änderungen und Irrtümer vorbehalten. | Technical modifications and mistakes reserved.

Mit den Angaben im Katalog und in den Datenblättern werden Produkte beschrieben, nicht Eigenschaften zugesichert. Belastung mit „Grenzwerten“ (einfache Kombination) ist zulässig ohne bleibende Schäden der Produkte. Betrieb der Geräte mit Grenzwertbelastung für längere Zeit kann die Zuverlässigkeit beeinträchtigen. Grenzwerttoleranzen unterliegen üblichen Schwankungen. | Products are described by information contained in catalogs and data-sheets. It is not be considered as assured qualities. Stresses listed under „Maximum Rating“ (one at a time) may be applied to devices without resulting in permanent damage. The operation of the equipment for extended periods may affect device reliability. Limiting value tolerance are subject to usual fluctuation margins.

## 10 Characteristics

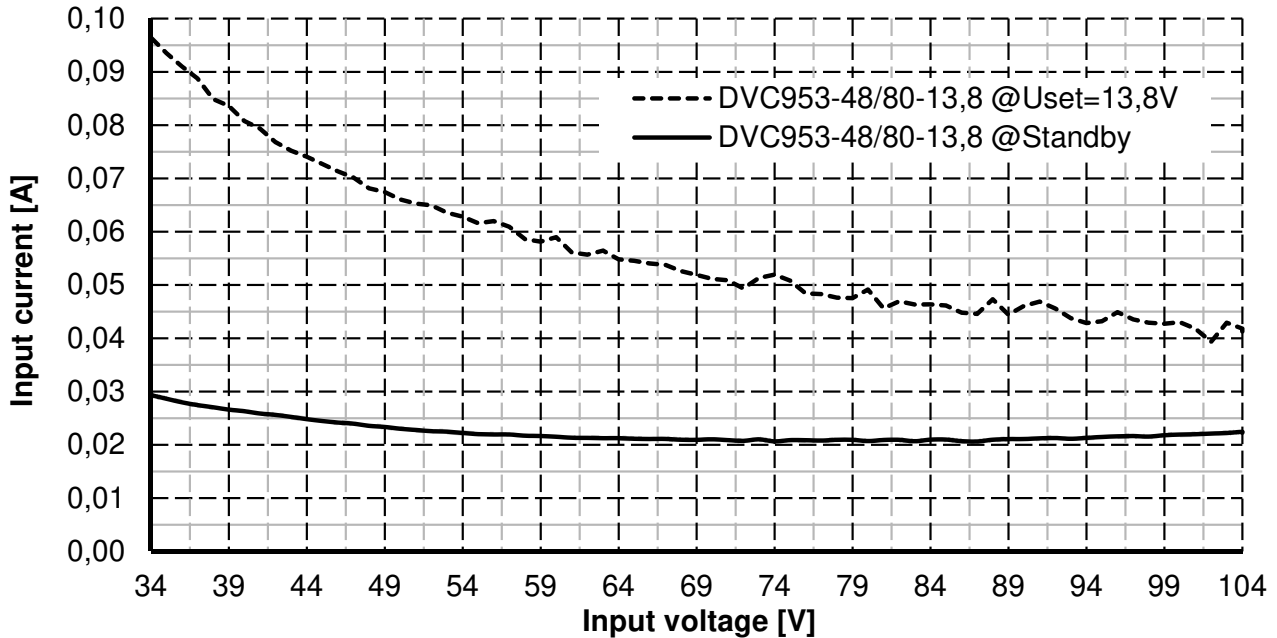
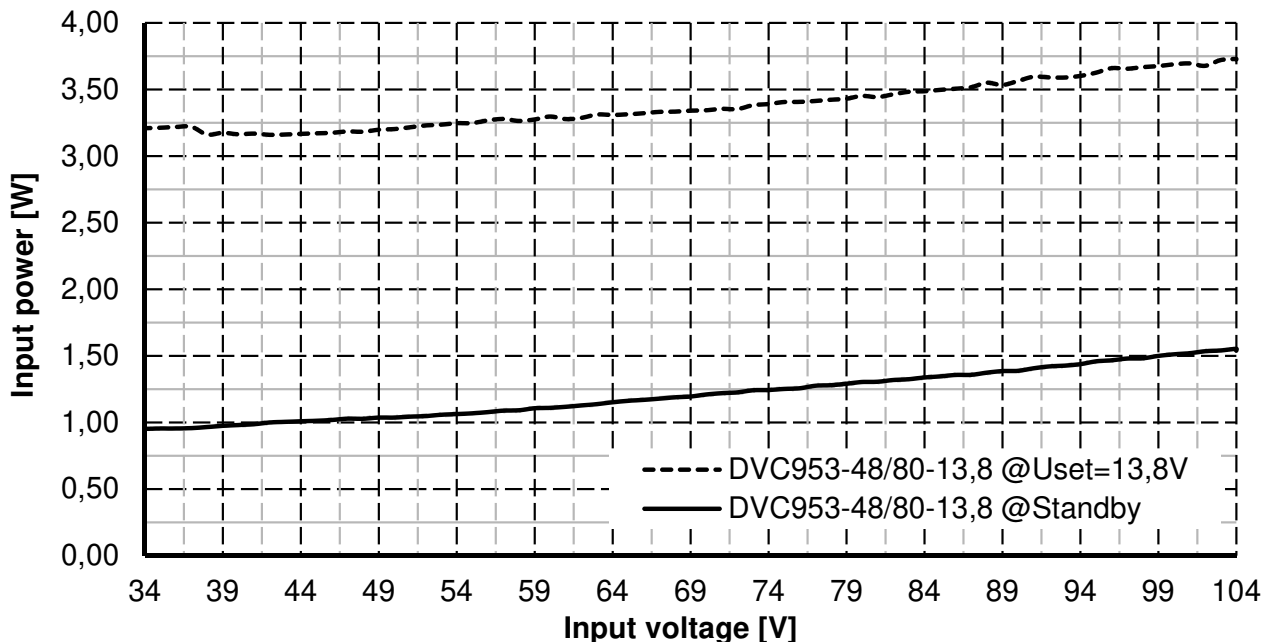

Figure 10.1: No-load current consumption



## DC/DC converter module

## DVC953

Alle Daten gemessen bei 48/80VDC, 70A / 80A und 25°C Umgebungstemperatur, wenn nicht anders gekennzeichnet. | All parameters are specified at 48/80VDC, 70A / 80A and 25°C ambient, if not marked otherwise.  
 Technische Änderungen und Irrtümer vorbehalten. | Technical modifications and mistakes reserved.

Mit den Angaben im Katalog und in den Datenblättern werden Produkte beschrieben, nicht Eigenschaften zugesichert. Belastung mit „Grenzwerten“ (einfache Kombination) ist zulässig ohne bleibende Schäden der Produkte. Betrieb der Geräte mit Grenzwertbelastung für längere Zeit kann die Zuverlässigkeit beeinträchtigen. Grenzwerttoleranzen unterliegen üblichen Schwankungen. | Products are described by information contained in catalogs and data-sheets. It is not be considered as assured qualities. Stresses listed under „Maximum Rating“ (one at a time) may be applied to devices without resulting in permanent damage. The operation of the equipment for extended periods may affect device reliability. Limiting value tolerance are subject to usual fluctuation margins.

Figure 10.2: No-load input power

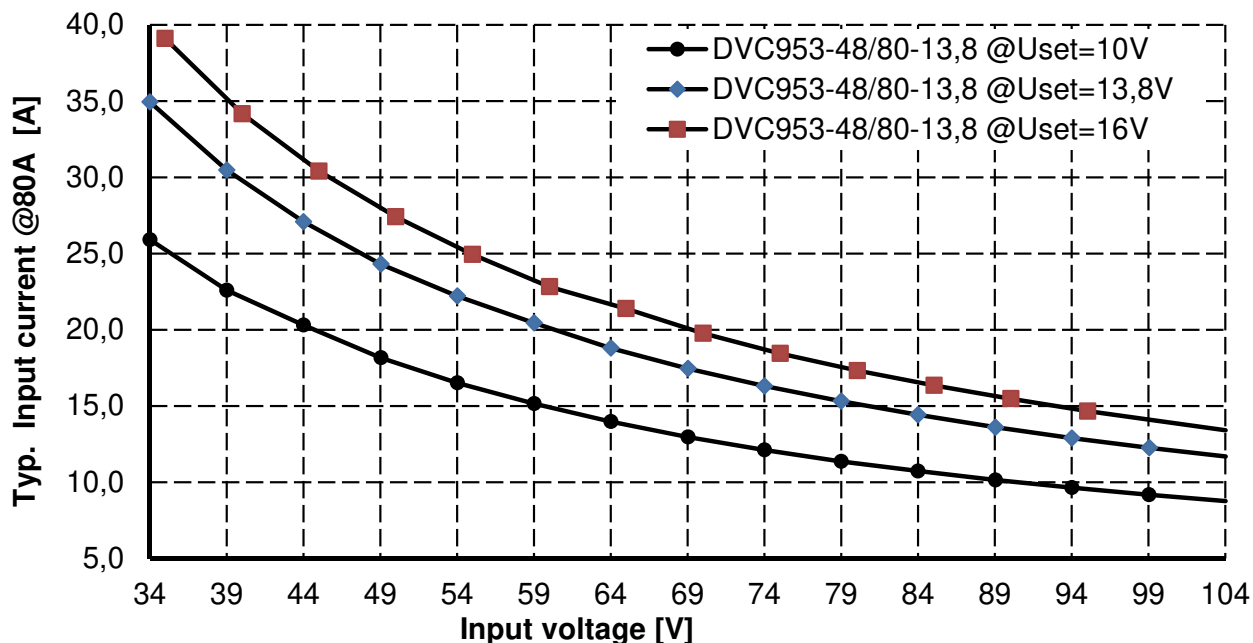

Figure 10.3: current consumption at maximum output current

## DC/DC converter module

## DVC953

Alle Daten gemessen bei 48/80VDC, 70A / 80A und 25°C Umgebungstemperatur, wenn nicht anders gekennzeichnet. | All parameters are specified at 48/80VDC, 70A / 80A and 25°C ambient, if not marked otherwise. | Technische Änderungen und Irrtümer vorbehalten. | Technical modifications and mistakes reserved.

Mit den Angaben im Katalog und in den Datenblättern werden Produkte beschrieben, nicht Eigenschaften zugesichert. Belastung mit „Grenzwerten“ (einfache Kombination) ist zulässig ohne bleibende Schäden der Produkte. Betrieb der Geräte mit Grenzwertbelastung für längere Zeit kann die Zuverlässigkeit beeinträchtigen. Grenzwerttoleranzen unterliegen üblichen Schwankungen. | Products are described by information contained in catalogs and data-sheets. It is not be considered as assured qualities. Stresses listed under „Maximum Rating“ (one at a time) may be applied to devices without resulting in permanent damage. The operation of the equipment for extended periods may affect device reliability. Limiting value tolerance are subject to usual fluctuation margins.

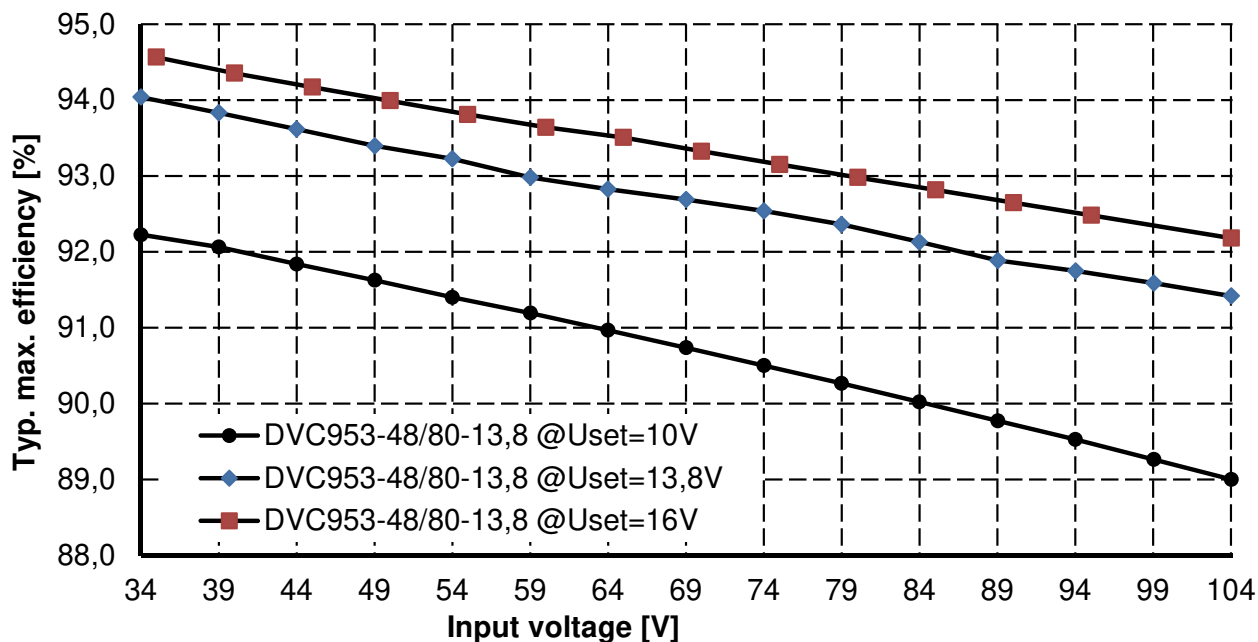

Figure 10.4: Maximum efficiency depending on input voltage

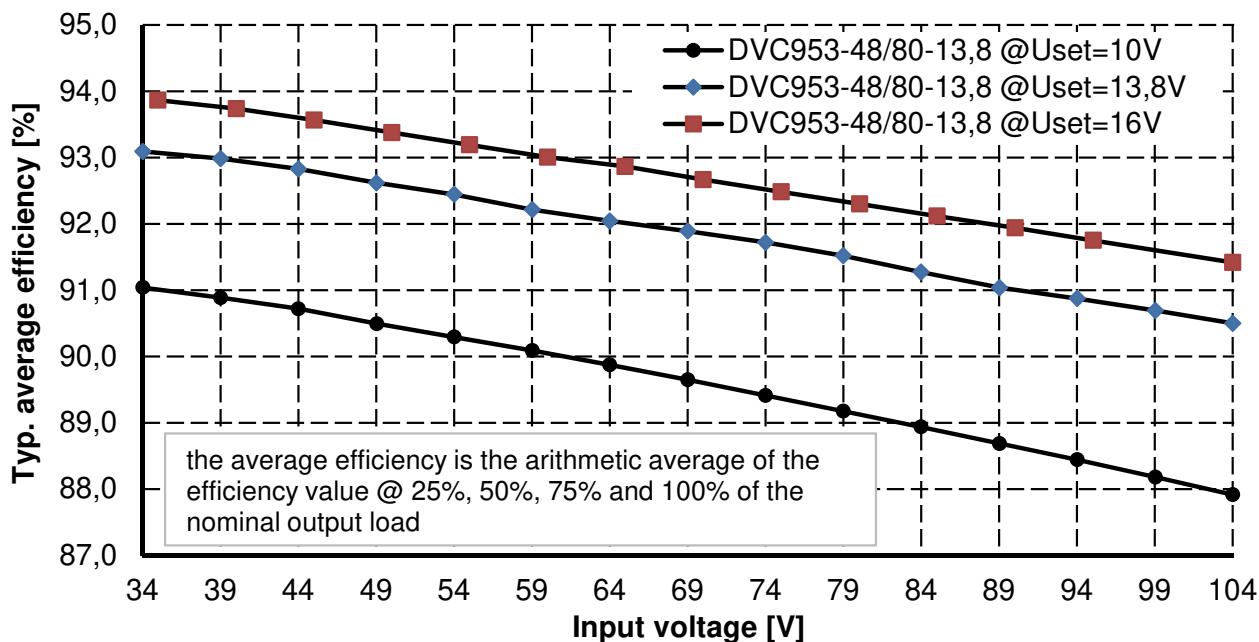

Figure 10.5: Average efficiency depending on input voltage

## DC/DC converter module

## DVC953

Alle Daten gemessen bei 48/80VDC, 70A / 80A und 25°C Umgebungstemperatur, wenn nicht anders gekennzeichnet. | All parameters are specified at 48/80VDC, 70A / 80A and 25°C ambient, if not marked otherwise. Technische Änderungen und Irrtümer vorbehalten. | Technical modifications and mistakes reserved.

Mit den Angaben im Katalog und in den Datenblättern werden Produkte beschrieben, nicht Eigenschaften zugesichert. Belastung mit „Grenzwerten“ (einfache Kombination) ist zulässig ohne bleibende Schäden der Produkte. Betrieb der Geräte mit Grenzwertbelastung für längere Zeit kann die Zuverlässigkeit beeinträchtigen. Grenzwerttoleranzen unterliegen üblichen Schwankungen. | Products are described by information contained in catalogs and data-sheets. It is not be considered as assured qualities. Stresses listed under „Maximum Rating“ (one at a time) may be applied to devices without resulting in permanent damage. The operation of the equipment for extended periods may affect device reliability. Limiting value tolerance are subject to usual fluctuation margins.