

# Reimagining the User Experience

## Touch Encoder

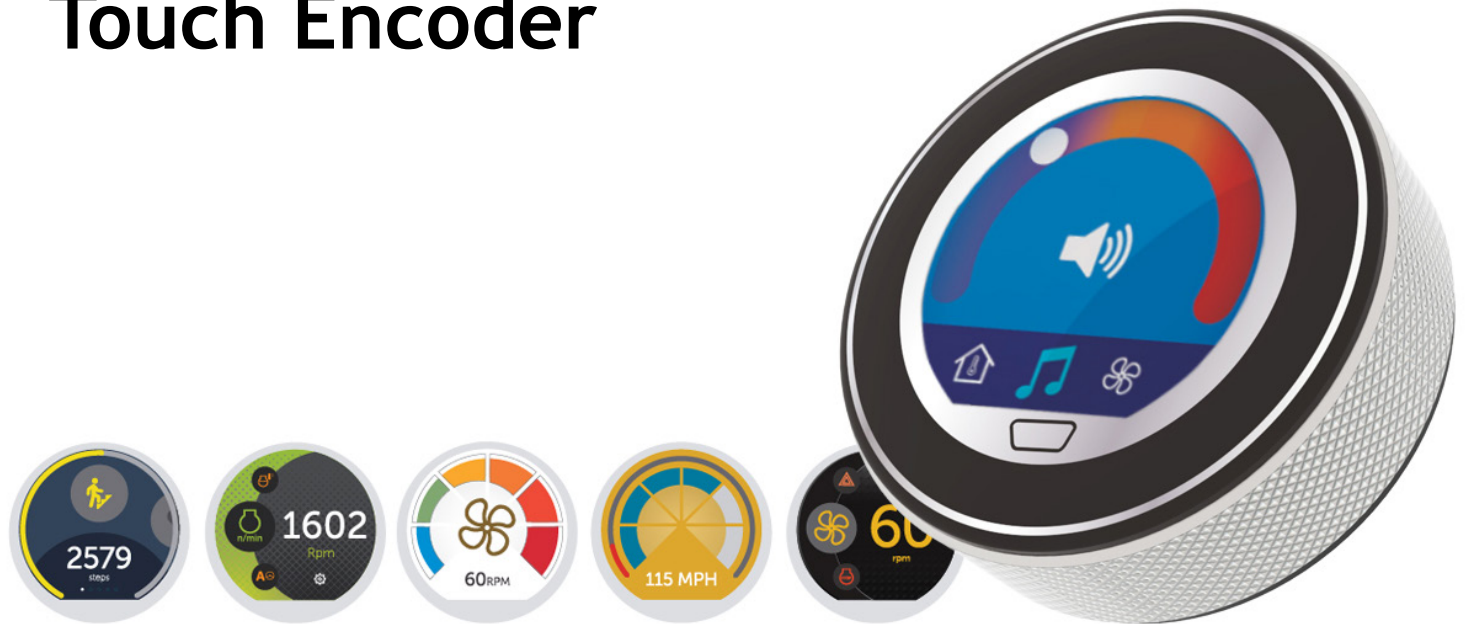

### KEY FEATURES

- Replaces many traditional user input devices (such as switches, keypads, pushbuttons, displays, etc.) with a simple, easy to use device
- Optimal front panel footprint
- Supported gestures: Tap + Swipe + Turn
- High resolution display: 330 PPI (320 X 300)
- Quick user interface development
  - Intuitive tablet based development platform
  - Library of configurable standard widgets
- Stores hundreds of screens (32MB memory)
- Incorporates pictures: PNG, JPEG, etc.
- Field upgradable application and firmware
- Robust: sealed to IP67, high impact strength, chemical resistant
- 1,000,000 encoder cycles
- USB 2.0 or CAN J1939 communications with host device

### MATERIALS

- Cover lens: polyester
- Knob: 304 stainless steel with optional black chrome finish or silicone grip
- Rear housing: nylon
- Mounting nut: nylon
- RoHS 2018/863 compliant

### TOUCHSCREEN/DISPLAY

- Optically bonded display and touchscreen for excellent sunlight readability
- Touchscreen construction: high resolution PCAP ITO

## General

Device Diameter (O.D.): 2.200 in (55.88 mm) Nominal
Display Diameter (V.A.): 1.320in (33.50 mm) Nominal
Touchscreen: Projected Capacitive
Display - Type: Round Color TFT LCD, 320 X 300
Display - Brightness: 200 Cd/m2
Positions/Revolution: 32
Connector Style: M12 5-Pin Connector or PC Board Connector

## Environmental

Operating Temp. Range: -20 to 65 °C
Storage Temperature: -30 to 70 °C
Humidity: 95% @ 65 °C
Mechanical Shock: ANSI EP455 5.14.1
Seal (Electronics): IP67
Radiated Immunity: IEC 61000-4-3 80 - 2700 MHz 10 V/M
Conducted Immunity: IEC 61000-4-6 LEVEL 2 - 130 dBµV, 150 KHz to 80 MHz
ESD: IEC 61000-4-2: 8 kV Contact; 15 kV Air
Vibration (Random): 50 - 2000 Hz, 2hr Each Axis ANSI EP455 5.15.2
Chemical Resistance: Designed to survive repeated exposure to most chemicals found in Medical, Off-Highway, and Industrial applications
Solar Radiation: ISO 4892.2 Method B
Power Frequency Magnetic Field: Meets IEC 61000-4-8, 100 A/m
Electrical Fast Transient/Burst: IEC 61000-4-4 ±1kV Coupling Clamp
Conducted Emissions: EN 55011, EN55032 Class B
Radiated Emissions: EN 55011, EN55032 FCC Part 15 Class B

For more information, contact us at [TE@grayhill.com](mailto:TE@grayhill.com)

## Part Numbers

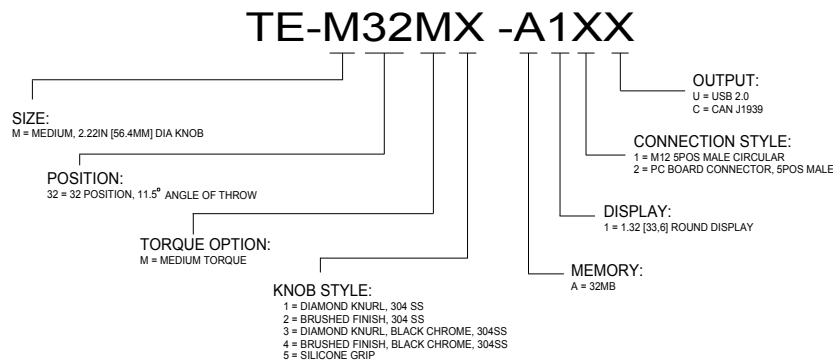

Software Development Kit P/N: **TE-M321-SDK (without iPad) & TE-M321-SDKT (with iPad)** \* iPad is a registered trade mark of Apple Corporation

## Inside the Kit:

- Touch Encoder Development Module
- CANbus Interface Cable
- Red Programming Cable
- Power to USB Cable
- Power Supply Wall Mount
- Thumb drive
- White USB Micro B to USB Type A Adapter Cable



## Mechanical

Pushout Force (Max): 45 lbs (200 N)
Pullout Force (Max): 45 lbs (200 N)
Side Load Force: 45 lbs (200 N)
Lens Hardness: 2H
Lens Impact: IK5
Mounting Torque (Nominal): 4 - 10 in-lbs
Mounting Torque (Max): 14 in-lbs
M12 Connector Torque (Max): 14 in-lbs
M12 Connector Pull-Out: 15 lbs (66.7 N)
Mounting Alignment (Maximum): < 1Deg
Weight (Production Unit): 4.25 oz (120.6 g)

## Electrical Function

Operating Voltage: SDK: 4.75 to 5.25 Vdc; Component: 4.75 to 18 Vdc;
Max Operating Power: 1.5 W @ Max Brightness
Memory: 32MB
Standby Power Mode: < 100 mW
Sleep Mode Wakeup Time: 500 mSec
Boot Time: 5 Seconds to O.S.
USB Interface: 2.0 Full Speed Composite Device
CANbus Interface: J1939 Compliant

## Encoder Function

Initial Rotational Torque: 3.50 ± 2.00 in-oz (Medium Torque Option)
Rotational Life: 1,000,000 Cycles
Detent Type: Ball Spring
Encoder Sensing Technology: Hall Effect

multiple projects

Simulate your program on the iPad before downloading it to the Touch Encoder

Create individual screens using any combination of widgets (from the widget library), pictures and graphics

Scroll up and down to see all of the screens on your workspace

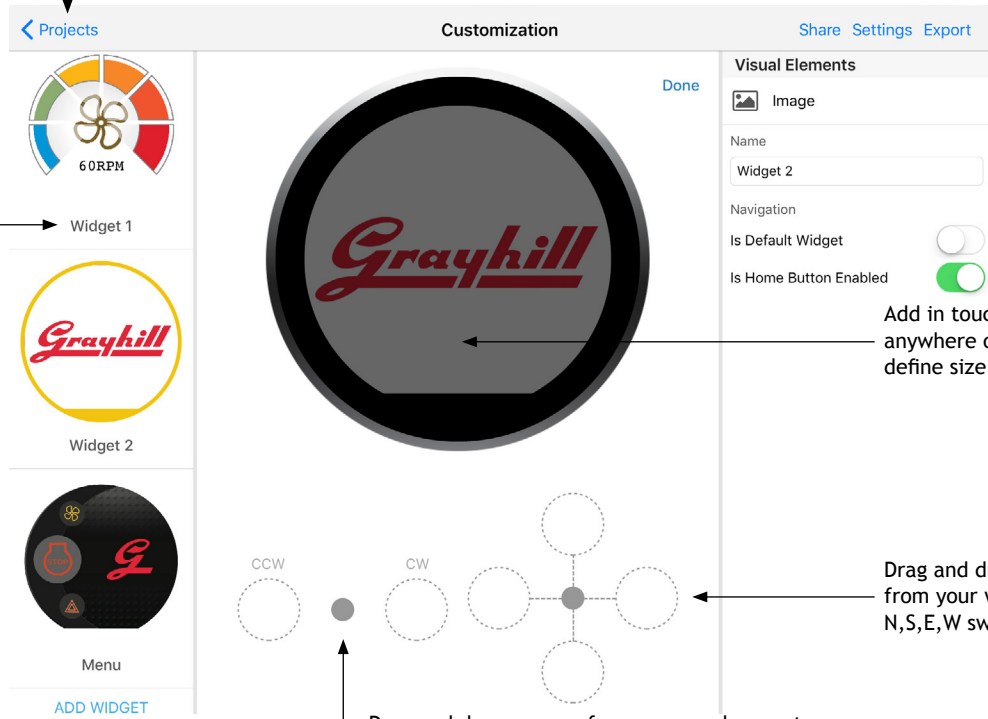

Add in touch zones; Tap anywhere on the screen to define size and location

Drag and drop screens from your workspace into N,S,E,W swipe zones

Drag and drop screens from your workspace to define what happens when the knob is rotated

## Fully Customizable Standard Widgets

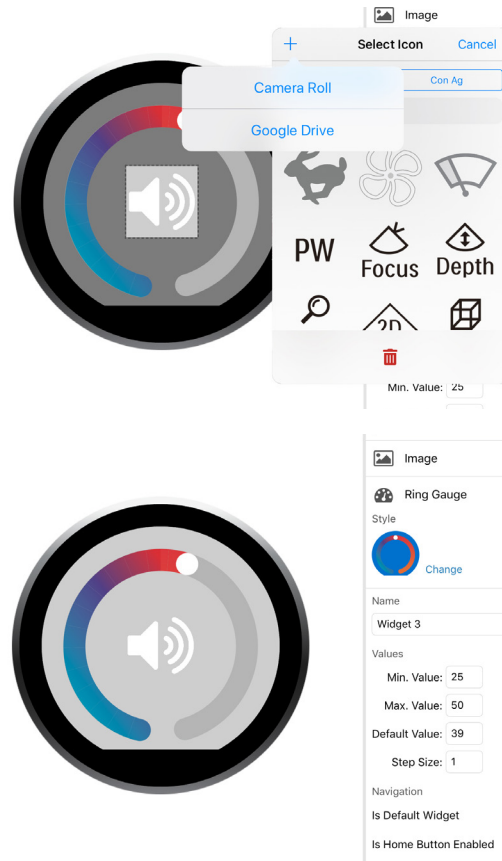
Select icon from Menu

Change colors

Determine values/increments for rotary movements



**GRAYHILL**

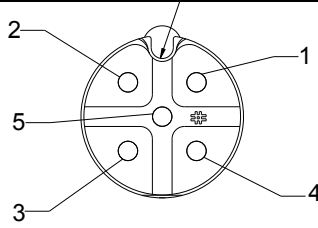

PIN #	USB	CAN
1	MODE	MODE
2	VIN	VIN
3	GND	GND
4	USB_D+	CAN_H
5	USB_D-	CAN_L

connect mode pin #1 to GND at power up.  
Leave mode pin #1 open for run mode  
(normal operation)

**Mode Pin Truth Table @ Power up**

Program Mode	GND
Run Mode	Open

**Mounting Information**

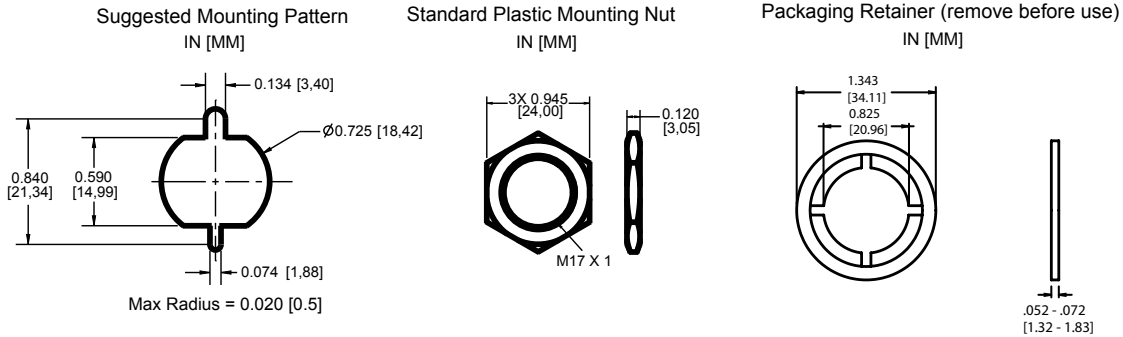

**Dimensions**

**TE-M32MX-A12X (PC Board 5-Position Male)**  
IN [MM]

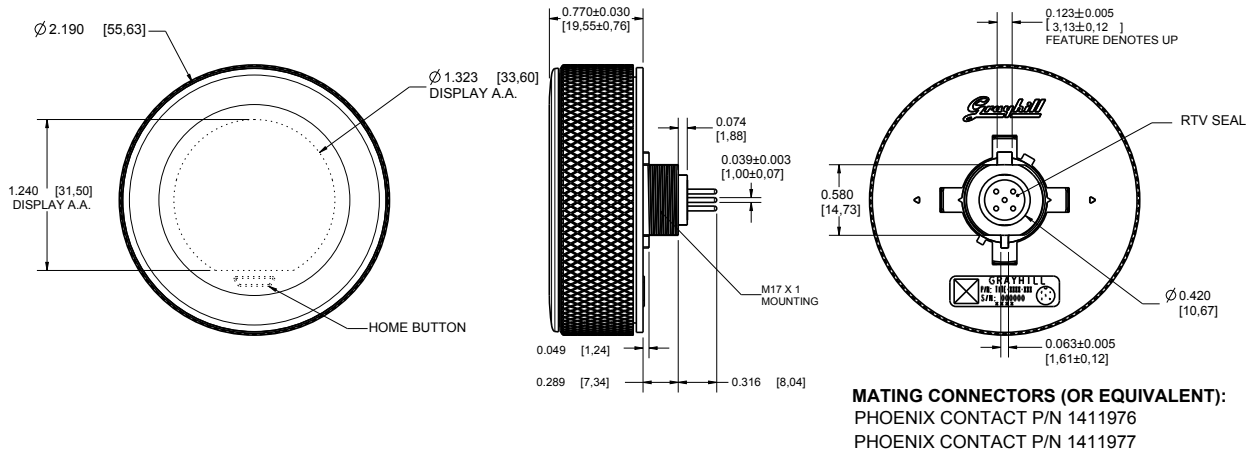

**TE-M32MX-A11X (M12 5-Position Male)**  
IN [MM]

